

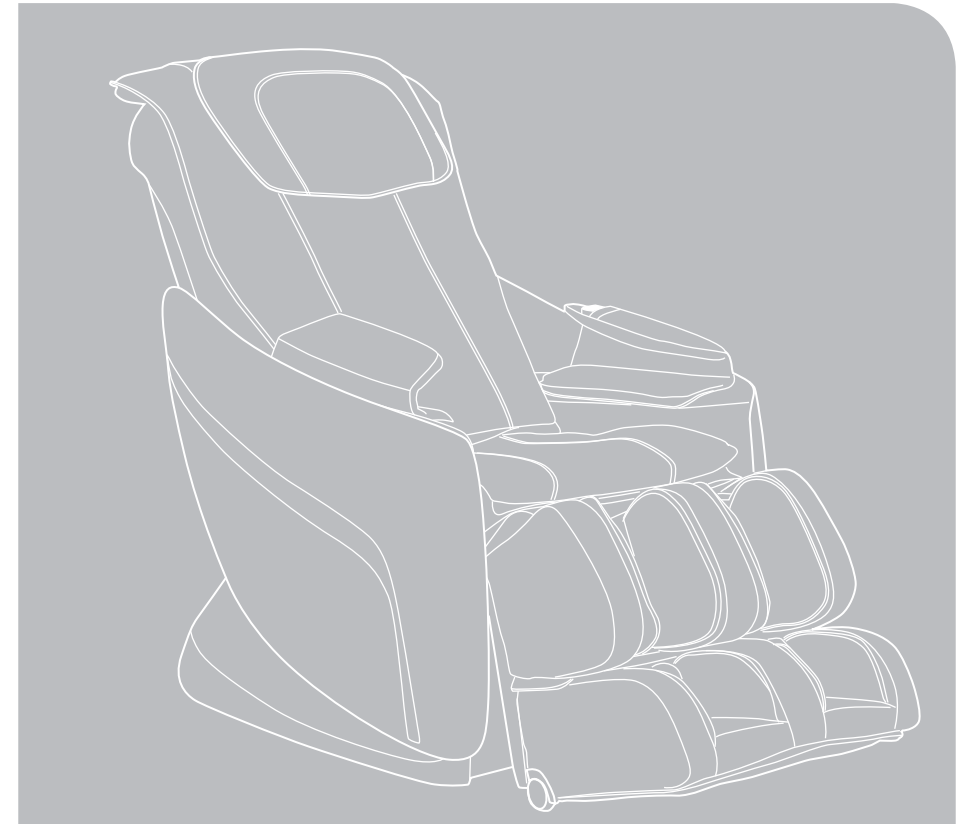

14515 E Don Julian Rd, City of Industry, CA 91746
Tel: 1-877-977-0656
Fax: 1-800-521-4712
Email: service@cozziausa.com



CZ-328
Massage chair

Use & Care Manual

See more product update at:

WWW.COZZIAUSA.COM

See more product update at:

WWW.COZZIAUSA.COM

Welcome To **cozzia**

Thank you for purchasing the CZ-328 massage chair. Before using your chair, please read the contents of this instruction manual and refer to it when needed.

COZZIAUSA.COM

CZ-328

Massage chair

TABLE OF CONTENTS

Safety Precautions	01-05
Chair Components	06-07
Chair Specifications	08
Chair Installation	09-11
Moving the Chair	12
Operation Guide	13-17
Grounding Instructions	18
Troubleshooting	19
Product Care and Storage	20
Warranty Information	21-23
Warranty Card(Attachment)	

SAFETY PRECAUTIONS

IMPORTANT SAFETY INSTRUCTIONS

When using the massage chair, basic precautions should always be followed, including the following:

Read all instructions before using this massage chair.

DANGER—To reduce the risk of electric shock:

- Always unplug this massage chair from the electrical outlet immediately after using and before cleaning.
- Never use pins or other metallic fasteners with this appliance.
- Carefully examine the covering before each use. Call for service if the covering shows any sign of deterioration, such as blistering, peeling or cracking.
- Keep dry—Do not operate in a wet or moist condition.

WARNING—To reduce the risks of burns, fire, electric shock or injury to persons:

- Read all instructions before using.
- A massage chair should never be left unattended when plugged in. Unplug from the outlet when it is not in use and before putting on or taking off parts.
- Close supervision is necessary when this massage chair is used by or near children or disabled persons. Keep children away from reclining backrest and extended leg rest.
- Use this massage chair only for its intent use as described in this manual.
- Never operate this massage chair if it has a damaged cord or plug, if is not working properly, if it has been dropped or damaged, or dropped into water. Contact Customer Service Department.
- Keep the cord away from heated surfaces.
- Never operate the massage chair with the air openings blocked. Keep the air openings free of lint, hair and the like.
- Never drop or insert any object into any opening.
- Do not use outdoor.
- Do not operate where aerosol (spray) products are being used or where oxygen is being administered.



- To disconnect, turn all controls to the off position, then remove the plug from the outlet.
- Do not stand on or in the massage chair. Use only while seated.
- The product is not intended for use by children or persons with reduced physical, sensory or mental capabilities, or lack of experience and knowledge, unless they have been given supervision or instruction concerning use of the product by a person responsible for their safety.
- Children should be supervised to ensure that they do not play with the product.
- Temperatures sufficiently high to cause burns may occur regardless of the control setting. Do not use on an infant or invalid or on a sleeping or unconscious person. Check the skin in contact with the heated area of the appliance frequently to reduce the risk of blistering.
- Burns may result from improper use.
- Do not crush in order to avoid sharp folds.
- Keep children away from extended foot support (or other similar parts).
- DO NOT WET.
- DO NOT USE PINS.
- NEVER REMOVE COVER.
- Connect this appliance to a properly grounded outlet only. See Grounding Instructions.

SAVE THESE INSTRUCTIONS

This massage chair is intended for household use only.

1. Usage Environment

- Do not use the massage chair in an excessively humid or dusty environment as this may result in malfunction or electric shock.
- Do not use the massage chair in a room with a temperature of 104° F or higher.
- Do not expose the massage chair to heaters, stoves or direct sunlight.
- Place and use the massage chair on an even, non-slip floor.
- The massage chair is designed for home use and not for commercial purposes.



Caution

- This massage chair is to be used indoors only.
- If you use the massage chair in a cold room, do not increase the room temperature abruptly. It is recommended that you increase the temperature gradually to a normal level.
- If the massage chair is stored in a cold place and is being brought into a warm environment, it is advisable to wait for one hour before use. This is because its performance may not be at optimum level, as there may be water droplets on the mechanical parts due to consideration. Using the massage chair under such conditions may result in malfunction.

2. Safety Precautions

- To ensure safe and correct use of the massage chair, do not operate it without reading this operation manual carefully.
- Do not use the massage chair when the upholstery or seat is removed. This may cause injury or malfunction.
- Do not use the massage chair in combination with other therapeutic equipment or electric blanket etc., as this may result in ineffectiveness or injury.
- Do not use the massage chair an hour before or after eating as this may have adverse effects on the user.
- Do not allow children or pets to play around the massage chair, e.g. behind the backrest, under the seat base or legrest of the massage chair. This may result in injury.
- Do not use the massage chair when your body is wet.
- Do not operate the massage chair with wet hands.
- It is not recommended to use the massage chair for more than 15 minutes.
- Do not perform continuous massage on the same spot of your body for more than 5 minutes at a time as this may result in excessive stimulation and may have adverse effects.
- Do not insert your hand or foot along the paths of the massage rollers during use as this may cause injury.
- Stop operation immediately if you feel any discomfort.
- This product is not intended for self-treatment of conditions that should be managed by a qualified health care provider.
- People on medication or with medical conditions, please consult your doctor before use. Please do not use the product if you are not feeling well.



3. People with Medical Conditions

Consult your doctor before use if you:

- are under medical rest as ordered by a doctor.
- have spinal disorders, an abnormal spinal condition or have suffered a spinal injury.
- have back problems.
- have diabetes, osteoporosis or sensory impairment.
- have joint dysfunction such as rheumatism, hammertoe or gout.
- have a pacemaker or other electronic medical devices.
- may be pregnant.
- have phlebitis or thrombosis.
- have an increased risk for blood clots.
- had recent surgery.
- Have surgical pins, screws, or anything mechanical in the legs, ankles or feet.



Caution

- This massage chair is not intended for use by children or persons with reduced physical, sensory or mental capabilities, or lack of experience and knowledge, unless they have been given supervision or instruction or instruction concerning use of the massage chair by a person responsible for their safety.
- Children should be supervised to ensure that they do not play with the massage chair.
- Avoid using the massage chair under the influence of alcohol.
- Do not apply massage rollers directly on the head, elbow or knee joints, torso or abdomen.
- If your legs or feet slip off the leg rest during massage, do not force them back in as this may result in injury.
- Remove the power plug from the electrical outlet immediately should liquid be accidentally spilled onto the massage chair. Do not use wet hands to connect or disconnect the power plug from the electrical outlet.
- Do not tamper with the power cord or use the massage with a damaged cord as this may result in malfunction and electric shock.

4. Instances When the Massage Chair Should Not Be Used

In the following events, please switch off the main power switch immediately and disconnect the power cord from the electrical outlet:

- If water is accidentally spilled onto the massage chair. This may result in electric shock or malfunction.
- If the fabric of the backrest is torn and the internal components are exposed.
- If pain or discomfort is felt during massage, stop operation immediately and consult your doctor.
- If you detect any malfunction or any other abnormal condition during operation.
- If there is power failure. Injury may occur when power is restored unexpectedly.
- If there is lightning.

5. Assembly and Repair of the Massage Chair

- Do not disassemble the backrest cover of the massage chair. Touching the internal components may result in malfunction or electrical shock.
- This massage chair must only be professionally serviced or repaired. Do not attempt to disassemble or repair the massage chair by yourself.

6. Things to Be Noted About the Power Plug and Cord

- Check that the Alternating Current (AC) voltage corresponds with the specifications indicated for the massage chair.
- Do not connect or disconnect the power plug from the electrical outlet with wet hands. This may result in malfunction or electric shock.
- When disconnecting the power plug, pull it by holding the plug, not the cord.
- Although operation will be stopped automatically by the Auto-Timer function, always remember to switch off the main power after use.
- Do not place the power cord under the massage chair or any other heavy objects.
- Do not wind the power cord around the massage chair as this may damage the cord and result in a fire or electric shock.
- Do not operate the massage with a damaged cord or extension cord.
- Do not use the massage if the electrical outlet is loose.
- If the power cord is damaged, it should be replaced by a qualified technician.

CHAIR COMPONENTS

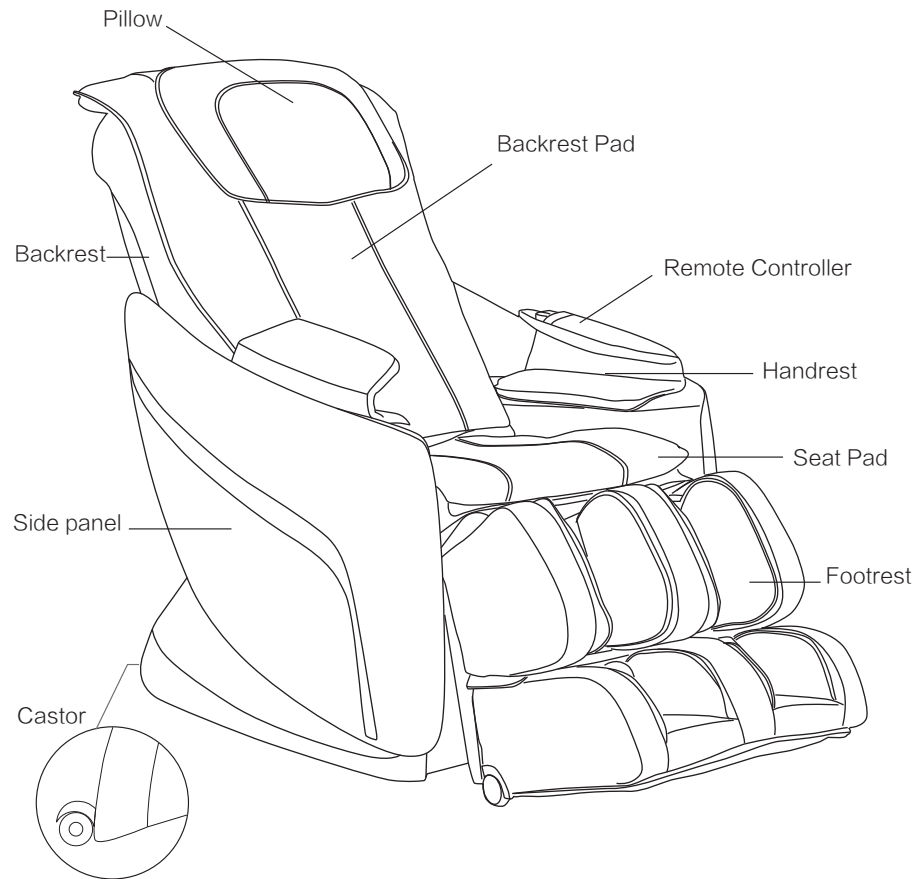

Massaging position

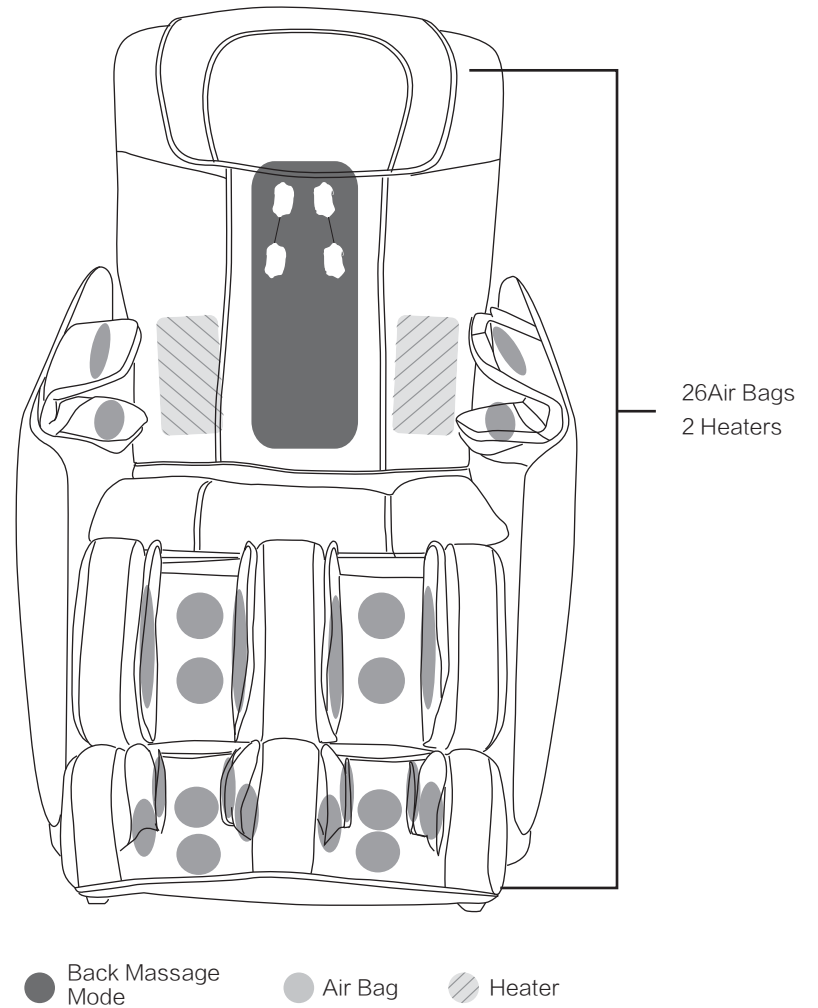



CHAIR SPECIFICATIONS

Description	Specification	
Model No.	CZ-328	
Rated Voltage	110-120V	
Rated Frequency	60Hz	
Power Consumption	100W	
Timer	5/10/15/20/25/30 minutes	
Max. Time Rate	30 minutes	
Dimensions (L x W x H)	70.3" x30.1" x33.9"	
Weight	Gross weight:	217.8 lbs
	Net weight:	176 lbs
Length of wiring	Controller wiring 59"	
	Power supply wiring 70.9"	
Usage condition	Environmental temperature 10°C- 40°C Contrasting humidity level 30-85RH	
Storage condition	Storage temperature 20°C-60°C Storage humidity level 30-85RH	
Safety feature	Equipped with overheating and power surge detectors	
Using benefits	Increasing blood circulation, relieving muscular fatigue.	

CHAIR INSTALLATION & MOVING

Note: Ensure sufficient space around the chair. When backrest reclining and footrest is being raised, the minimum 31.5" space must be ensured both at the front and the back of chair. Bottom of the chair may damage the tatami mattress or floor. It is recommended to spread a mat under the chair.

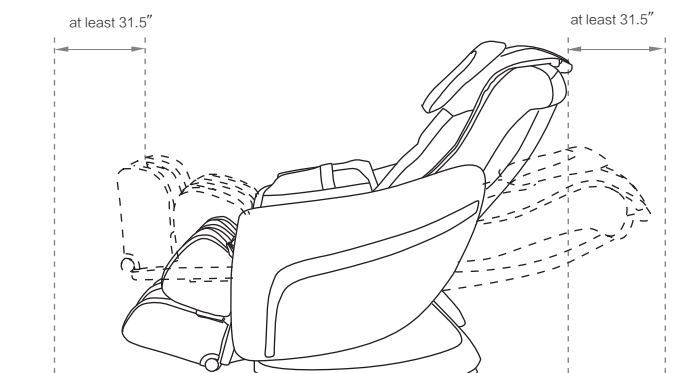

Step 1:

- Take the chair out from box and put the controller on the pocket of left armrest.

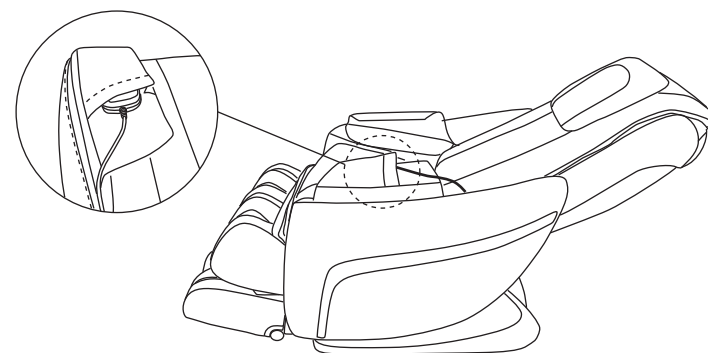

Step 2:

- Attach the backrest pad to the backrest by Velcro and zipper.

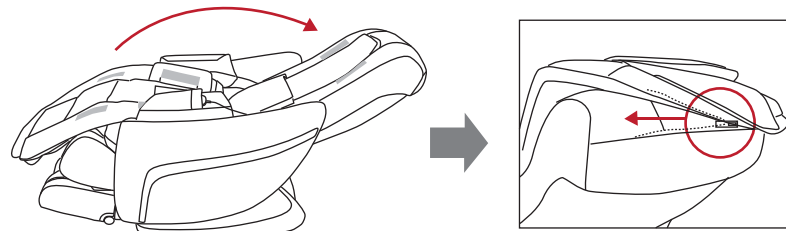

Step 3:

- Do remember to put the heater wire on the interval of the seat and side panel in order to avoid damage.

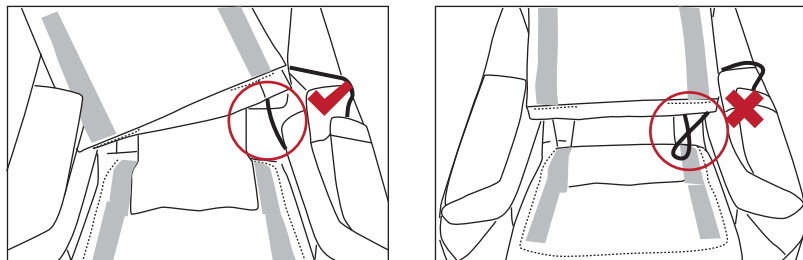

Step 4:

- Attach the seat pad to the seat by Velcro. And then attach the seat rest to the foot rest by zipper.

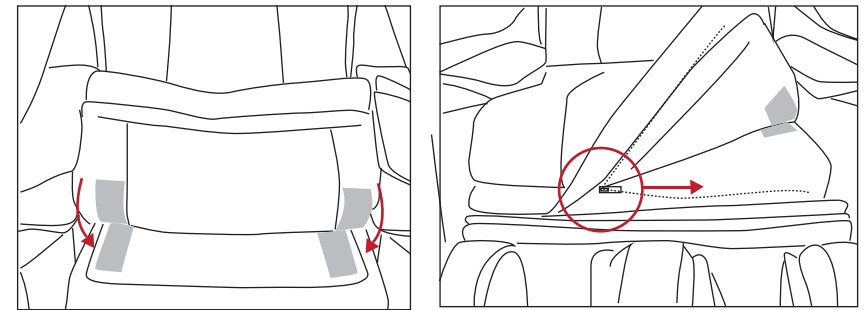

Step 5:

- Connect the chair to the power supply and turn on the power switch. And then chair will get back to its original sitting position.

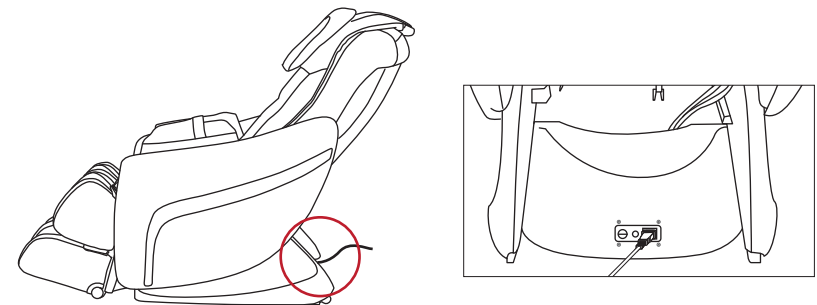

Step 6:

- Enjoy your massage!

MOVING THE CHAIR

1. Restore the footrest to its original position.
2. Recline the chair to tilt approximately 45 degrees. Move the chair using the wheels as the fulcrum.

Note:

- Always return the footrest to its original length and restore it to its original position before moving the chair, otherwise injury during movement may result.
- Do not move the chair while a person is seated on it.
- Place a mat on the floor and gently roll the chair over it to avoid damaging the floor.

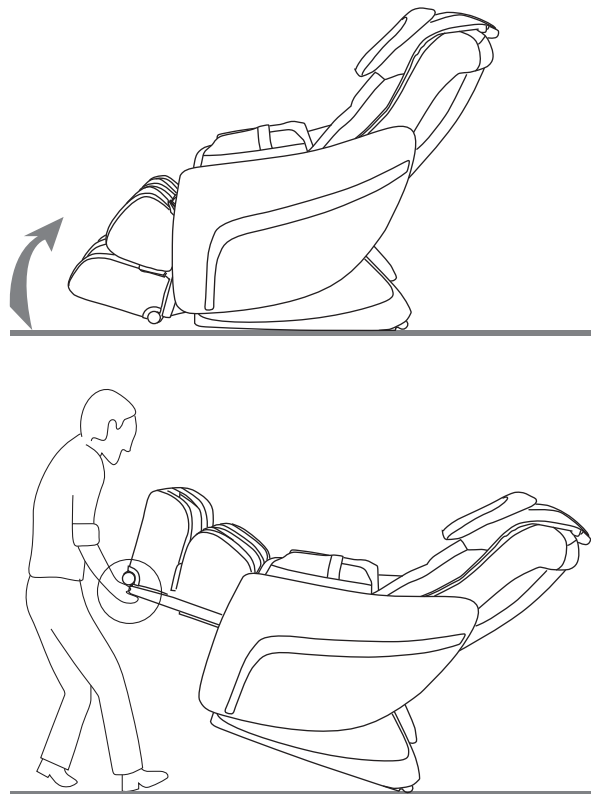

OPERATION GUIDE

Connect to the power supply, and turn the switch to “I” position, chair is now in idle mode.

During its idle mode ON/OFF button will blink.

During its idle mode, only ON/OFF, Pause, Leg rest Recline/Restore, Back rest Recline/Restore buttons can work.





Control Buttons for the Massage Chair

1. ON/OFF

The Start/Stop Control Button

Press this button to light up the LCD screen. Press any massage function button to start massage. This will initiate the timer function. Press this button again to stop all massage functions, massage chair will return to its original position.

2. TIMER

Time interval Control Button

When a massage function is activated, the timer is preset at 15 minutes. Every single press on this button will change the timer interval in the sequence of “20>25>30>5>10>15>20” minutes in circle.

When only one minute left, 5 beeps will be sounded to alert the user.

Note: Screensaver will come out if no operation on the controller within three minutes. Any press on the main function button will light up the screen and press again to change to the new function.

3. PAUSE

Press this button once to pause the massage function temporarily. During pause mode, the pause icon will blink on the liquid crystal display.

Press this button again to cease the “Pause” function and resume previous massage function as well as countdown timer.

4. SENSUAL



Press the button once, massage chair will move into the preset position, then start to massage. Every single press on this button will change the massage mode in the sequence of “SENSUAL1> SENSUAL2>idle mode ” in circle.

5. LEGREST RECLINE AND RESTORE

Angle Adjustment Button for Leg rest

Keep pressing either button until the legrest reaches your desired position.

6. CHAIR RECLINE AND RESTORE

Keep pressing  or  to comfortably lay flat or restore the chair to its original position.

Full body Auto massage program

7. RELAX

8. THERAPY

9. STRETCH

10. G-MAX

11. MANUAL MASSAGE

KNEADING, SWEDISH, TAPPING, SHIATSU, CLAPPING, ROLLING

Press this button to activate rhythmic kneading manual massage function for a full back massage at direction one. Every single press on this button, manual massage function will change in the sequence of “KNEADING> SWEDISH> TAPPING> SHIATSU> CLAPPING> ROLLING> STOP” in circle.

12. MESSAGE DIRECTION

When KNEADING, SWEDISH, TAPPING, SHIATSU or CLAPPING massage function is engaged, press this button to change the rhythmic mode between direction 1 and direction 2.

13. SPEED

The Speed Adjustment Button for Kneading, Tapping, Clapping, Swedish and Shiatsu function.

When Tapping, Clapping, Swedish or Shiatsu function is engaged, every single press on this button will change the massage speed interval in the sequence of “Lv1 > Lv2 > Lv3 >Lv4 > Lv5” in cycle.



14. SPOT/PARTIAL

The Spot or Partial Back massage

Press this button once to activate localized Spot Massage while the original massage mode continues to run at the latest position. Every single press on this button will change the massage function in the sequence of “SPOT < PARTIAL < STOP” in circle.

Note: Partial Massage will take the latest position as the center to perform Partial Massage with the distance approx. 8 cm. SPOT/PARTIAL button is only effective under MANUAL MASSAGE mode. SPOT function cannot be achieved while ROLLING function is activated.

15/16. UPWARD/DOWNWARD ADJUSTMENT

The position adjustment button for spot and partial massage.

When the spot and partial massage function are activated, this button can be used to move the massage rollers.

Hold this button to move the massage rollers upward/downward respectively. Release the buttons when reaching desired position.

17/18. WIDTH

The Width Adjustment Button for Tapping, Clapping, Shiatsu and Rolling function.

When Tapping, Clapping, Shiatsu or Rolling function is engaged, every single press on these two buttons can adjust the massage width into Narrow or Medium or Wide.

19. FULL AIR

The auto full body air function start/stop control button.

Press this button to activate a full body air pressure massage. Press the button again to cease the function.

Note: Once press Manual Air button, it will switch from Full Air function to Manual Air function.

20. MANUAL AIR

Press this button to activate body air pressure massage from shoulder to soles. Every time this button is pressed, manual air massage function will change in the sequence of CALF&FOOT > ARM > STOP .

Note: Once press Full Air button, it will switch from Manual Air function to Full Air function.

21. INTENSITY

The Intensity Adjustment Button for Air pressure massage, 5 levels of intensity to be adjusted.

When Air massage function is engaged, every single press on this button will change the air intensity in the sequence of “Lv1 > Lv2 > Lv3 > Lv4 > Lv5” in cycle.

22. STRENGTH

When Kneading function is engaged, every single press on this button will change the massage strength interval in the sequence of “Lv1 > Lv2 > Lv3 > Lv4 > Lv5” in cycle.

Note: When massage function RELEX, RELIEF, THERAPY, FULL AIR, MANUAL AIR or MANUAL MASSAGE is engaged, every single press on the SPEED or INTENSITY buttons can adjust the massage speed, strength or air pressure.

23. HEAT

Lumbar Heat function Start/Stop Control Button

Press this button to activate lumbar heat function, press this button again to stop the Heat function.

Note: During Auto Program mode, pressing this button can also disable/enable the Heat function.

Finish Operating

Please press the “ON/OFF” button after use. Massage Rollers will restore to its original position; then switch the power supply button under the chair to “O” and unplug the machine from the wire socket.

GROUNDING INSTRUCTIONS

This product must be grounded. If it should malfunction or break down, grounding provides a path of least resistance for the electric current to reduce the risk of electric shock. This product is equipped with a cord with an equipment-grounding conductor and a grounding plug. The plug must be plugged into an appropriate outlet that is properly installed and grounded in accordance with all local codes and ordinances.

Danger—Improper connection of the equipment-grounding conductor can result in a risk of electric shock. Check with a qualified electrician or service technician if you provided with the product—if it will not fit the outlet, have a proper outlet installed by a qualified electrician.

This product is for use on a nominal 120V circuit and has grounding plug that looks like that plug illustrated below. Make sure that the product is connected to an outlet having the same configuration as the plug. No adapter should be used with this product.

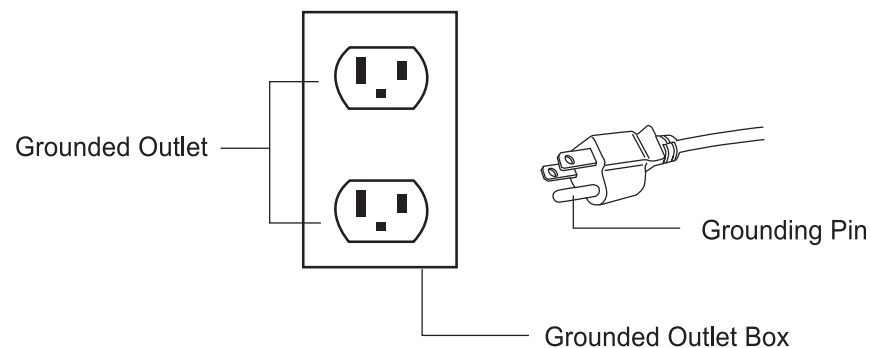

TROUBLESHOOTING

This massage chair is controlled by a microcomputer and is thus susceptible to power surges of +10 to-15%. The following situations may arise in the event of a power surge:

Situation	Solution
The massage chair is connected to the power supply but is not functioning	<ol style="list-style-type: none"> 1. Check to see that the plug is properly connected and working 2. Ensure the massage chair switch is in the 'I' position
The remote control works but the massage chair is not functioning.	Possible overheating due to prolonged use. Turn off the power for at least 30 to 50 minutes
Both the remote control and the massage chair are not functioning	<ol style="list-style-type: none"> 1. Ensure the chair is plugged into a working outlet 2. Turn the power OFF and ON again

If you continue to have problems, please read the warranty card and contact service department.



PRODUCT CARE AND STORAGE

1. Storing the Massage Chair

- Wipe off dust and dirt from the massage chair with a dry, soft, clean cloth after use.
- Keep the massage chair clean and away from places of high humidity.
- If the massage is not to be used for a long period of time, cover the massage chair with a dust cover and unplug its power plug from the electrical outlet.

Caution

- Do not store the massage chair in direct sunlight or in places of high temperature. This may cause the color of the upholstery to fade.
- Do not allow the massage chair to remain in contact with vinyl or wallpaper for extended periods of time as this could lead to discoloration.

2. Cleaning the Massage Chair

- Before cleaning, ensure that the main power switch is off and the power plug is disconnected from the electrical outlet.
- Wipe off dust and dirt from the massage with a dry, soft, clean cloth after each use.
- This product can be cleaned thoroughly with a slightly damp cloth.
- Do not iron the upholstery.
- Do not wash the upholstery using a home washing machine as this may result in deterioration of the upholstery's quality.

Caution

- Do not use abrasive cleaning agents like benzene or thinner to clean the massage chair. This may cause the upholstery to fade.

3. Cleaning the Controller

- Use only a clean, dry cloth to clean the controller.

Caution

- Do not use a wet cloth to clean the controller. This may result in malfunction.

WARRANTY INFORMATION

COZZIA products have the following warranty:

COZZIA's massage chairs, motion upholstery and home theater massage seating provide a one year in-home service warranty and a two-year parts warranty. COZZIA customer service will not issue Return Material Authorizations (RMAs) for products. COZZIA products will be either repaired by the consumer or by an in-home technician. COZZIA will not issue Return Material Authorizations (RMAs) for buyer's remorse.

Service And Technical Support

Consumers may contact COZZIA's customer service department at 1-877-977-0656 between 9:00 am and 5:00 pm PST, Monday through Friday for warranty or service issues.

Consumers are required to provide the unit serial number and dated proof of purchase (sales receipt) when they contact the COZZIA service department regarding a repair.

A COZZIA customer service representative will attend to most consumer inquiries, but in some cases a technical service specialist will provide advanced support.

Non-warranty repair is provided on a "per incident" basis. COZZIA customer service will verify that the unit has failed and provide instructions for repairing a unit. All applicable repairs, parts, shipping, handling, local tax and a "per incident" fee will be charged for non-warranty repairs and support calls.

Proof of purchase (original receipt) is required for all warranty repairs or service.

Product Repairs

Many COZZIA product repairs may be performed by the consumer in their own home with parts and instructions supplied by COZZIA such as remote controller replacements that don't require a technician.

Canadian consumers may contact COZZIA's customer service department at



1-877-977-0656 between 9:00 am and 5:00 pm PST, Monday through Friday for warranty or service issues.

- **Floor Models and Demonstration Units** have a prorated warranty period that begins the day the model is placed on the floor and connected to an electrical outlet by the retail partner. Proof of purchase is required in order to obtain warranty service and parts. Non-warranty parts and service are available at a “per incident” charge.
- **Warranty Coverage Period** – Warranty coverage starts at the time that the consumer PURCHASES their chair. Proof of purchase is required for all warranty repairs. The warranty time period is measured by continuous calendar days based on a seven-day week.
- **Field Service** – COZZIA customer service department will diagnose and schedule an authorized service provider to repair the chair in the consumer's residence.
- **Parts** – All parts deemed necessary for repairs will be shipped to the consumer at no charge by the COZZIA service department.

CONSUMER WARRANTY LIMITATIONS AND EXCLUSIONS

- Warranties are only valid in the 48 contiguous United States and Canada and are contingent upon the consumer operating the chair according to the corresponding instruction manual.
- The warranty only applies to COZZIA products and does not include any accessories or enhancements.
- Field service requires pre-approval and must be performed by COZZIA's authorized field service personnel. Field service is only available in the United States and in major metropolitan areas in Canada.
- Softening of foams and filling composites in pillows, pads, and memory foam occurs naturally and does not constitute a defect under this warranty.
- Fading, wear and piling of fabrics occurs naturally and does not constitute a defect under this warranty.
- Natural markings, grain and dye variations in leather do not constitute a defect under this warranty.

- Warranties do not cover any loss or damage resulting from improper installation, unauthorized repairs or modifications, improper use of electrical/power supply, loss of power, dropped product, a malfunction or damage of an operating part from failure to provide manufacturer's recommended maintenance, transportation damage, theft, abuse, misuse, neglect, vandalism or environmental conditions (fire, floods, rust, corrosion, sand, dirt, windstorm, hail, earthquake or exposure to weather conditions), loss of use during the period the product is at a repair facility, or otherwise awaiting parts or repair.
- Damage due to shipping and handling does not constitute a defect under this warranty.
- Under no circumstance shall COZZIA or its representatives be liable for indirect, consequential, or incidental damages (including damages for lost profits, business interruption, bodily injury, medical and the like), even if any party has been advised of the possibility of such damages.
- Warranties are non-transferable and shall be in lieu of any other warranty, express or implied, including but not limited to any implied warranty or merchantability or fitness for particular use.
- COZZIA's sole liability and the purchaser's exclusive remedy shall be for the repair, or at COZZIA's option, for the replacement of the defective part. Notwithstanding the above, if replacements parts for defective materials are not available, COZZIA reserves the right to make substitutions in lieu of repair or replacement.

• **All warranties begin on the DATE OF PURCHASE; no allowance or extension is offered for delivery and/or installation.**

• **Warranties do not apply to rental, business, commercial, institutional or other non-residential users.**



Warranty Card

Model No.:CZ-328



WARRANTY REGISTRATION FORM

Product Serial No. (located on product) _____

Purchase price _____ Model No. _____

First Name _____ Last Name _____

Address _____

City _____ State _____ Zip _____

Phone _____

Email _____

Please mail to:

COZZIA USA LLC

14515 E Don Julian Rd

City of Industry CA 91746

Tel: 1-877-977-0656

Fax: 1-800-521-4712